

*M. Savytskyi, ScD, Professor  
T. Nikiforova, PhD, Associate Professor  
S. Grosman, post graduate  
SHEI «Prydniprovs'ka State Academy of Civil Engineering and Architecture»*

## **RATIONALE DESIGN MEASURES TO ENSURE THE RELIABILITY OF HIGH-RISE BUILDINGS IN PROGRESSIVE COLLAPSE**

*The results of studies on the justification of design solutions ensure reliable designs at progressive collapse were presented. Analysis of the stress-strain state of the structures was performed using software package «Lira 9.6». The most effective amount of stiffening diaphragms to ensure the reliability of the building was determined. The features of the impact on the reliability of the floor structure of the building was determined. The results of evaluation of the stability of columns of different types to explosive impact were presented.*

**Keywords:** *progressive collapse, reliability, reinforced concrete structures, composite structures, columns, diaphragm stiffness, finite element method.*

*М.В. Савицький, д.т.н., професор  
Т.Д. Нікіфорова, к.т.н., доцент  
С.А. Гросман, аспірант*

*ДВНЗ «Придніпровська державна академія будівництва та архітектури»*

## **ОБҐРУНТУВАННЯ КОНСТРУКТИВНИХ РІШЕНЬ ЩОДО ЗАБЕЗПЕЧЕННЯ НАДІЙНОСТІ ВИСОТНИХ БУДІВЕЛЬ ЗА ПРОГРЕСУЮЧИМ РУЙНУВАННЯМ**

*Представлено результати досліджень з обґрунтування конструктивних рішень щодо забезпечення надійності конструкцій за прогресуючим руйнуванням. Аналіз напружено-деформованого стану конструкцій проведено за допомогою програмного комплексу «Ліра 9.6». Визначено найбільш ефективну кількість діафрагм жорсткості для забезпечення надійності будівлі. Виявлено особливості впливу конструкції перекриття на надійність будівлі. Приведено результати оцінювання стійкості колон різного виду щодо вибухового впливу.*

**Ключові слова:** *прогресуюче руйнування, надійність, залізобетонні конструкції, сталезалізобетонні конструкції, колони, діафрагма жорсткості, метод скінченних елементів.*

*Н. Савицький, д.т.н., професор  
Т. Нікіфорова, к.т.н., доцент  
С. Гросман, аспірант*

*ГВУЗ «Приднепровская государственная академия строительства и архитектуры»*

## **ОБОСНОВАНИЕ КОНСТРУКТИВНЫХ РЕШЕНИЙ ПО ОБЕСПЕЧЕНИЮ НАДЕЖНОСТИ ВЫСОТНЫХ ЗДАНИЙ ПРИ ПРОГРЕССИРУЮЩЕМ ОБРУШЕНИИ**

*Представлены результаты исследований по обоснованию конструктивных решений обеспечения надежности конструкций при прогрессирующем обрушении. Анализ напряженно-деформированного состояния конструкций проведен с помощью*

программного комплекса «Лира 9.6». Определено наиболее эффективное количество диафрагм жесткости для обеспечения надежности здания. Выявлены особенности влияния конструкции перекрытия на надежность здания. Приведены результаты оценки устойчивости колонн разного вида при взрывном воздействии.

**Ключевые слова:** прогрессирующее обрушение, надежность, железобетонные конструкции, сталежелезобетонные конструкции, колонны, диафрагма жесткости, метод конечных элементов.

### **Introduction.**

Cases of chain collapse of buildings and structures recently have become more frequent. Generally, buildings are not designed for loading conditions to account for gas explosions, bomb explosions, vehicular collisions, aircraft collisions, tornados, karst caverns, shock impacts from transport crashes, flows in design, incompetent reconstruction etc. Therefore, when buildings are subjected to such abnormal loads, they may sustain extensive damage.



**Fig. 1. Progressive collapse in Riga supermarket Maxima**

Collapse of several buildings such as the Ronan Point Apartment Building in England in 1968, the Murrah Building in Oklahoma City in 1995 and the World Trade Center towers in New York in 2001 demonstrated that most casualties happen due to the building collapse. These disasters serve as a clear warning about dangers of a local failure that causes an entire building to collapse. Those were landmark events that alerted construction engineers to the importance of preventing progressive collapse in other similar buildings and as a result, research on disproportionate collapse has attracted particular attention over the past few years.

Although historical data indicate that the risk of progressive collapse in buildings is very low, loss of life and severe injuries would be significant when a multi-story building sustains a partial or total collapse. As a result several different government agencies have developed their own design requirements (GSA2003; DOD 2005, NISTIR 2007, CPNI 2011) to provide resistance against progressive collapse. Each agency has adopted different performance objectives for buildings subjected to abnormal loads. Furthermore, the design approach to provide resistance to progressive collapse is not standardized by these documents. In the private sector there is, however, a diverse range of professional opinion regarding the extent and nature of changes to present practices that may be warranted to enhance the resistance of buildings to progressive collapse. A consensus has yet to be reached on the thresholds to delineate when design against progressive collapse needs to be considered and what level of resistance is acceptable.

Prevention of progressive collapse requires the development of design technologies for frames that have high redundancy. The basic concept of the present collapse control design methods is to save human lives. Conventional ways to achieve this goal are usually stated as redundancy increase, adding continuous reinforcement to guarantee catenary effect in construction. All the researchers [18, 20] agree that other ways to reduce the repercussions of local failures are development of additional ways for load distribution and even more importantly ways to diminish influence of extreme load. All of these measures lead to price increase of a building to be devised.

The purpose of this paper is to consider and compare some of the design options and find their combination that will help to achieve the most cost efficient way to resist collapse propagation in the structure of multistoried buildings.

Design options considered in this article are usage of different amount and location of additional stiffeners – outrigger blocks, amplification of catenary effect in construction due to implementation of ribbed slabs and implementation of concrete filled steel tubes (CFST) as a bearing material for columns.

**Methodology.**

*Design approach.*

Forty stories high reinforced concrete spatial frame building (simplified unrealized project of Minsk Beacon tower) (fig. 2) was taken as a starting point for amplification. Typical floor plan with specified dimensions is presented on figure 3. Building height is 132 m (fig. 4). Stiffness and spatial immutability of the structure is achieved by a monolithic kernel.



**Fig. 2. View**

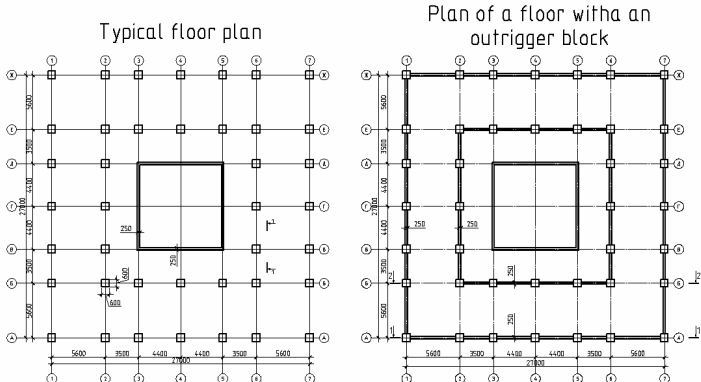

**Fig. 3. Typical floor plan**

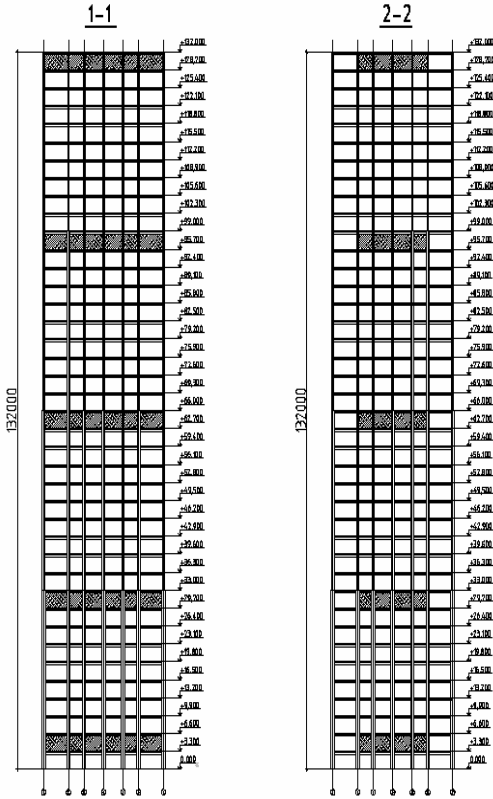

**Fig. 4. Cross section**

When a small part of a construction fails, the need for an alternate load path arises. Such conditions can lead to an increase of stresses and strains in the design members included in this alternate path. And if these exceed the safety factor, then the construction can experience failure. Design parts most susceptible to additional loading according to [16, 18] are considered to be horizontal bearing constructions. Thus implementing additional stiffeners into design can significantly boost its capacity for load redistribution.

Risk management approach should be adopted to govern design of the outrigger blocks system. According to research conducted in [20] abnormal loads occurring on the first floor are more probable, so it is considered advisable to place an outrigger block over the first floor, to create an alternative load path, employing the minimal amount of elements. Other outrigger blocks location and their optimal amount have been investigated in this paper. Cost efficiency of construction is taken as a criterion of optimal positioning.

Another way to boost stiffness of a construction is to add ribs to the slab structure. This can not only boost stiffness of a construction but also help diminish costs of the design. Experimental study of ribbed slabs performance in case of local failure was conducted in [22] by prof. Kantur O.V. Their experiments proved extensive durability of ribbed structured slabs. This paper will consider differences in catenary effect occurring in flat and ribbed slabs (fig. 5) and its impact on the total expenses for the design.

When designing a building using key-element approach, the usual key element is the columns, thus it is mandatory to ensure their durability [12]. Greatest threats are posed to columns when they experience lateral and bending loading additionally to their axial load. One of the reasons for such unpredicted loading is explosion. Explosion experiments and practice [2, 3, 10, 13] show that it takes a substantial amount of explosives to completely destroy a column cross section. On the other hand even a rather small amount of explosives can significantly damage the concrete in the column which can eventually lead to reinforcement buckling and column failure [17]. This work will consider the usage of concrete filled steel tubes as an option for bearing columns which can diminish a threat level and also decrease costs of the design.

#### *Numerical models.*

To compare all these options a numerical study has been conducted. Computation was performed using a program complex «LIRA 9.6», which can take into consideration both the material nonlinearities and geometrical nonlinearities. Since the overall task is a complex one a certain discretization approach has been adopted.

To analyze the overall influence the outrigger system a flat frame was fragmented out of the spatial structure. This simplification leads to more conservative results since it suggests the limit state (appearance of plastic joints) in all slabs around the segmented frame but it significantly reduce the computational costs of such task.

The columns and beams were modeled with beam finite elements (410). These elements can take into account for such nonlinear effects as concrete cracking and reinforcement yielding. They are based on Fiber model of a two node finite element with linear displacement function approximation and 6 degrees of freedom in each node (fig. 5,a).

Outrigger blocks were modeled with the shell four node finite elements (241) with 5 degrees of freedom in each node. These elements can also account for cracking and crushing of concrete and of smeared reinforcement yielding (fig. 5,b). Part of the finite element model is presented in fig. 7.

Nonlinear material properties were used for concrete and smeared rebar in the model. Engineering diagram of concrete properties was used with curved ascending branch (fig. 6). For smeared rebar an elastic-perfectly plastic diagram was utilized.

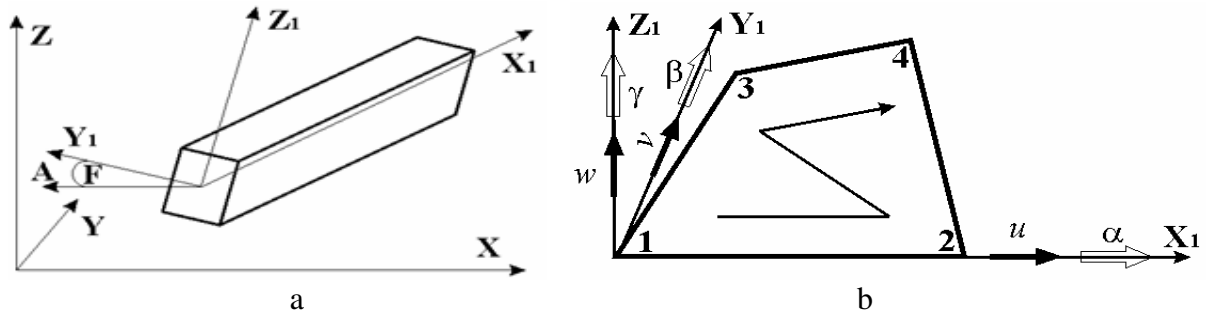

**Fig. 5. Finite element**

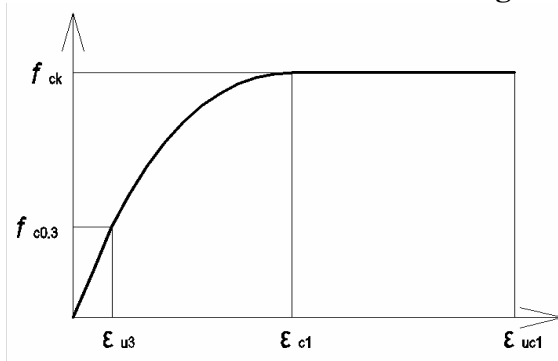

**Fig. 6. Material properties**

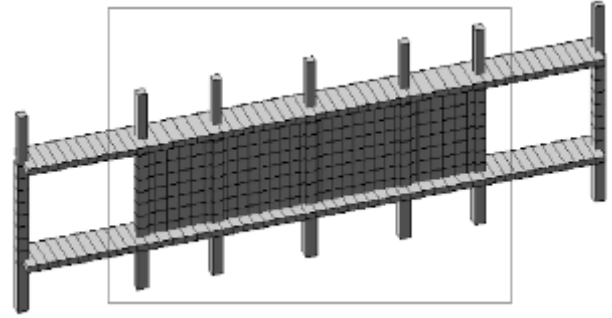

**Fig. 7. Part of finite element model**

A scenario-independent alternative load path method has been used to verify whether the structure has an adequate resistance against collapse to satisfy the national code [12] requirements. The analysis is therefore abstracted from the hazard so that robustness is introduced into the structure irrespective of the cause of the damage and, to some extent, irrespective of the extent of the damage. A scenario-independent approach is based on the assumption of a single column loss. The loss of a column will cause the gravitational load previously carried by it to be redistributed through the different load path to the adjacent columns. If the elements that form this load path are capable of withstanding this load in addition to their existing loads, the collapse is halted and the structure is stable in its damaged state. If, however, these elements do not have sufficient residual capacity to withstand the additional demand, they also fail and the collapse progresses. A similar cycle follows until and if such point is found that the structure offers sufficient residual capacity to arrest the collapse [20]. Removal of ground floor columns and columns located just over the floor with outrigger blocks were considered as these actions can show a most common load pass for probable local failure.

An important factor for consideration in our model is a dynamic load factor. According to [18] in the linear elastic range, the instantaneous loss of the column corresponds to a Dynamic Load Factor of 2.0. The introduction of plasticity typically reduces the dynamic amplification due to the dissipation of energy from the system. Studies have shown that much smaller amplification factors are usually appropriate (typically in the range 1.3 – 1.5, Marchand, 2004; Ruth, 2006). Considering experimental research conducted by Tihonov and Rastorguev [14, 15] the dynamic load factor was assumed to be 1.41.

In order to compare expenses and efficiency of different slab types submodeling a discretization approach was adopted. Thus we were able to analyze just one floor slab with fine mesh. Finite element model of fragmented floor is presented in fig. 8.

In this model both slab and beams are modeled with shell four node element (241). Reinforcement in slabs is modeled as smeared. Both transverse and longitudinal reinforcements in beams are directly modeled by 2 node link (1) elements with 3 degrees of freedom in each node (fig. 9).

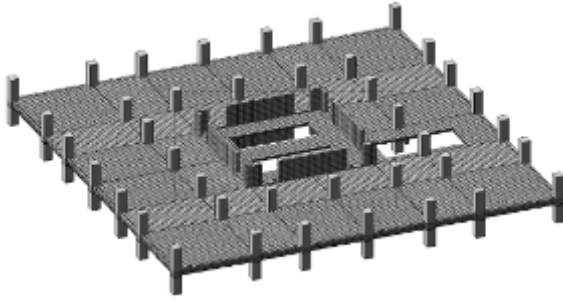

**Fig. 8. Part of finite element model**

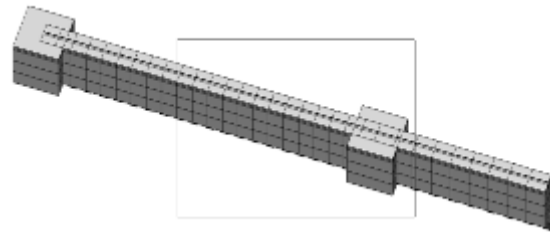

**Fig. 9. Detailed part beam**

Boundary conditions for this model are derived from previously calculated displacement results from the initial coarsely meshed model of the whole structure.

To assess vulnerability of different column types to extreme loads two different methods have been implemented.

First one was based on a finite element analysis of a single column subjected to bending, axial loading and torsion.

Two types of columns were analyzed a concrete filled steel tube column (CFST) and rectangular reinforced concrete column (RRC) (fig. 10). This analysis was conducted in a program complex «LIRA 9.6». Concrete core in both cases was modeled using 8 node solid elements (236) with 3 degrees of freedom in each node (fig. 11). These elements have the ability of cracking and crushing. In case of the equivalent strains in elements exceed the yielding limit the stiffness of the element is reduced. Steel tube was modeled using shell four node finite elements (241) with 5 degrees of freedom in each node. Rebar was modeled using a 2 node link (1) elements. Connection of steel rebar for the whole analysis was considered bonded. Connection of steel tube and concrete core was modeled using a 2 node element (252) of unilateral bond with a tension (compression) limit (fig. 12). To ensure concrete core to steel tube connection anchor devices were also modeled using link elements. Material properties data was taken from [5, 7, 8, 9, 11]. The FEM model is presented in figure 13.

The second method was based on the empiric data from the demolition with the usage of explosives manual [17]. We analyzed the amount of explosives (TNT) needed to destroy the construction. Mass of explosives was determined from the conditions of the location of the explosive on the outer surface of the column for at least three quarters of the circumference (perimeter). The amount of explosives was determined according to [17].

Concentrated contact charges for the demolition of concrete structures such as pillars, with a width of not more than twice the thickness are calculated in accordance with the formula (1) [17].

$$C = A \cdot B \cdot R^3, \quad (1)$$

where C – charge weight in kilograms;

A – factor depending on the properties of undermining material and explosives used (A=20);

B – factor depending on the location of the charge (B=9);

R – a radius of destruction in meters.

In case a demolished construction has a special outer reinforcement concentrated charges which are calculated according to the formula (1), are 6 times increased [17].

The load to the structure was applied as pressure distributed over the upper surface of the column. Load was applied in steps. The number of steps and the proportion of the load applied at each step were automatically determined by program based on the terms of the minimum margin of error for each of the iterations.

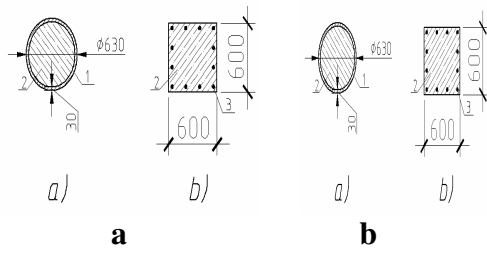

**Fig. 10. Cross section:**  
**a – CFST; b – RRC; 1 – Steel tube;**  
**2 – Concrete core 3 – Rebar**

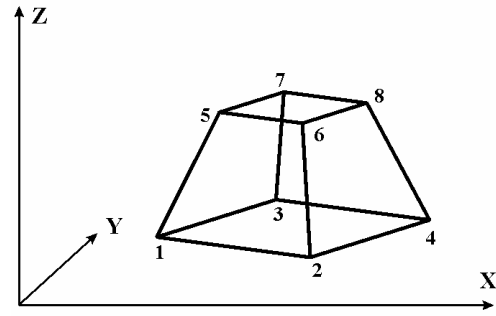

**Fig. 11. Finite element**

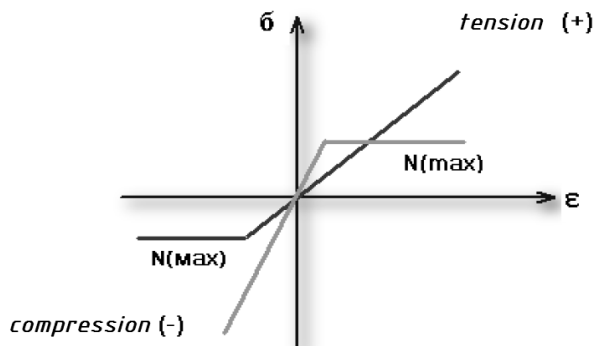

**Fig. 12. Finite element**

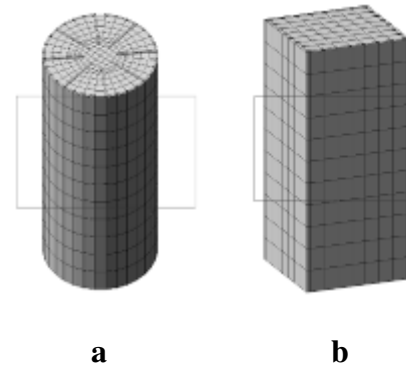

**Fig. 13. Finite element model:**  
**a – CFST; b – RRC**

With a very strong flexible rebar or in the presence of rigid reinforcement complete destruction of the concrete elements is not provided, if the charge weight is defined by the formula (1). In these cases the concrete elements if their destruction is necessary are considered to consist entirely of steel and charges for their demolition is calculated in accordance with formula (2) [17].

$$C = 6 \cdot A \cdot B \cdot R, \quad (2)$$

where C – charge weight in kilograms;

A – factor depending on the properties of undermining material and explosives used (A=20);

B – factor depending on the location of the charge (B=9);

R – a radius of destruction (m).

### **Results and discussion.**

From the presented in fig. 15 schemes it can be seen that in case of removal of the first floor column, redistribution of internal forces takes place in the outrigger blocks. And the stiffness of outrigger remains rather high so that the upper part of the column continues to work according to the same scheme. In case of removal of the column of the third floor the situation changes depending on the amount of outrigger blocks in the building. The column almost completely loses its bearing capacity and transfers its load to the nearby bearing constructions. As a result of the column removal axial load in the nearby columns can increase up to 1.2 – 1.3 in comparison with the strength design values.

Redistribution of the load can lead to compressive stress along the block diagonal reaching their yield limit (fig. 15). In case of the column removal outrigger block begins to work as a beam restrained with undamaged constructions and loaded by the failed column.

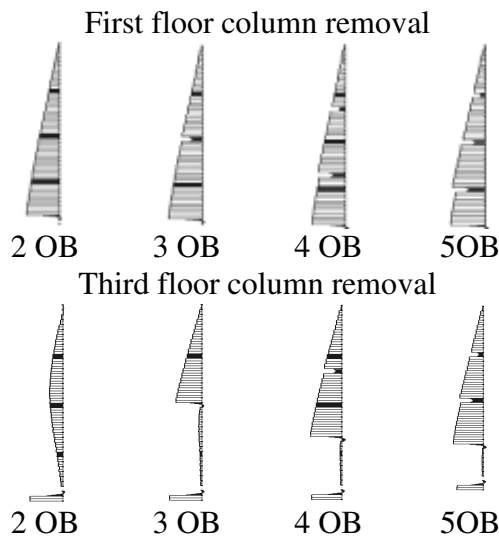

**Fig. 14. Influence of amount of outrigger blocks (OB) on axial force distribution in columns**

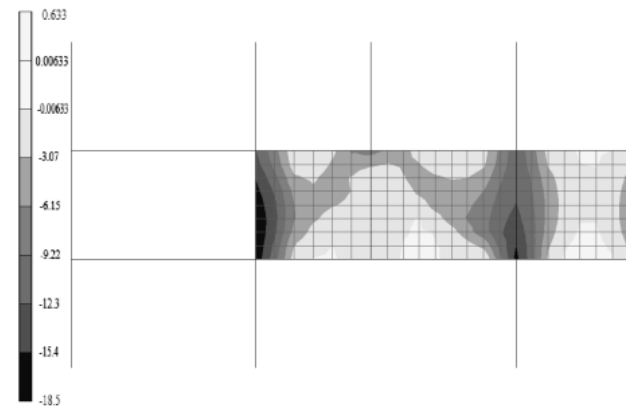

**Fig. 15. Stress distribution in OB**

Our results have proven that locating the outrigger block on the second floor can significantly influence the behavior of the system in case of unpredicted impacts and thus ensure the necessary durability to the construction on the whole, since it helps to limit the damage propagation just to the premises of the first floor.

Results for material consumption comparison are presented in fig. 16 and tables 1 and 2.



**Fig. 16. Total consumption of reinforcement per 1 sq. m.**

On the basis of these graphs it can be concluded that by increasing the quantity of outrigger blocks we can decrease the amount of reinforcements required to create an alternate load path in a high rise building. Another conclusion to be made is that after a quantity of outrigger blocks reaches 4, no significant rebar decrease can be observed.

The comparison of options showed that the scheme reinforced with beams is more rigid which determines the localization of displacement within a single floor cell. The zone of influence of the column removal is within the limits of cells adjacent to the failed element (fig. 17, which meets the requirements for localization of the effects of the destruction of structures, but the rigidity of the flat slabs is much lower than the rigidity of the beam model (up 25%).

Contour plots of shell moments state that for the case of beam floor forces occurring in the slab are significantly (2-3 times) lower than the forces occurring in a flat slab (fig. 18). This fact is explained by the role of the beams in the distribution of loads and tensions  $N_x$ ,  $N_y$  in the footing plate zone.



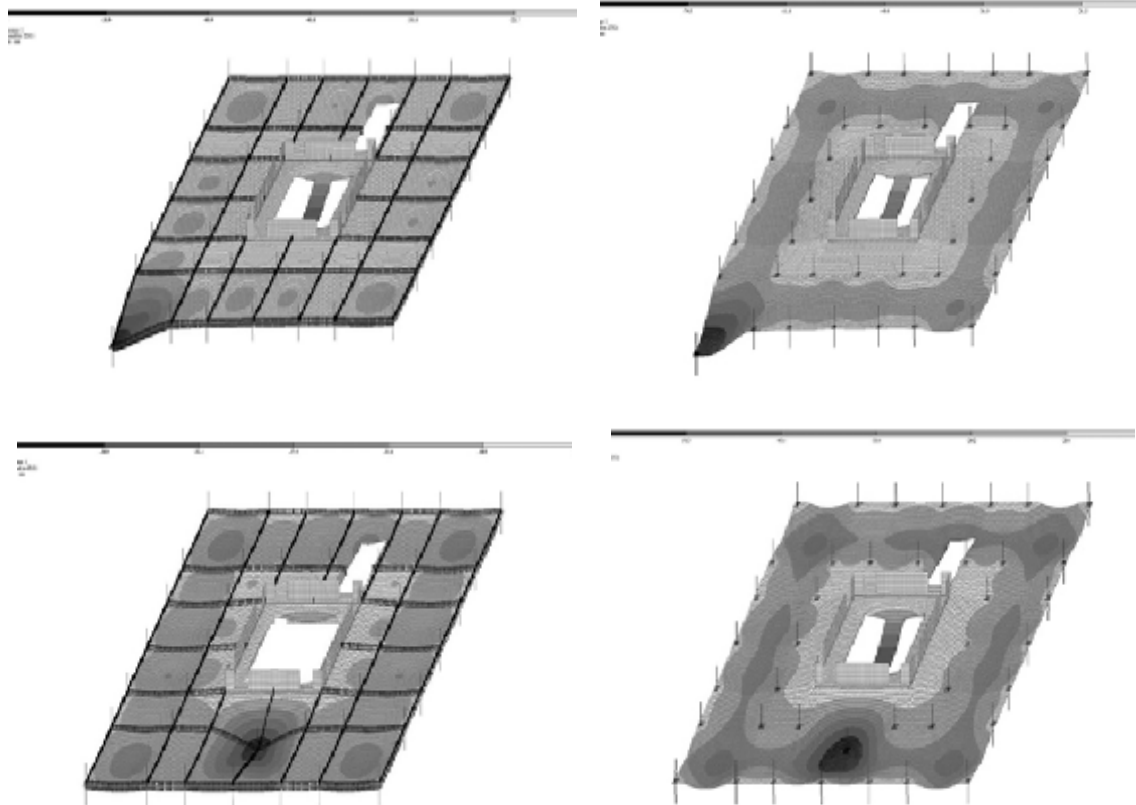

**Fig.17 Vertical displacement of floor structure**

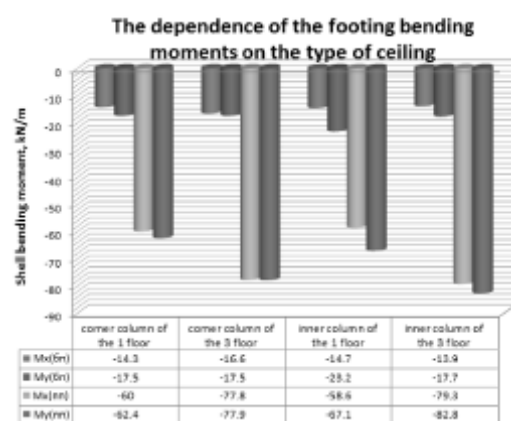
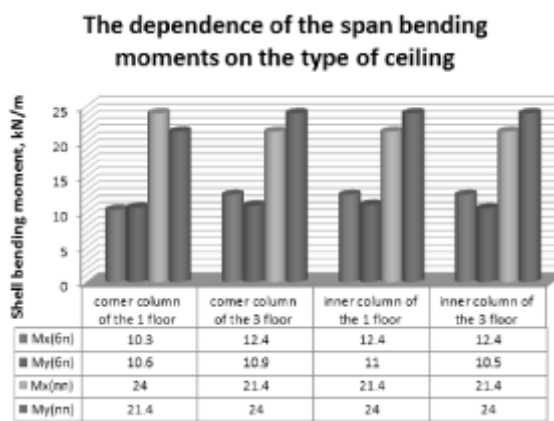
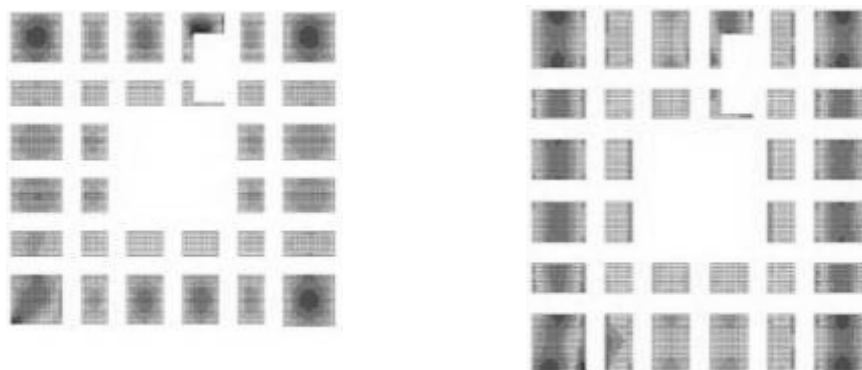

**Fig. 18. Dependency of bending moments on the construction of the slab**

Removal of the column leads to a change in schemes of work of slab. In case of the corner column removal the work scheme of the slab transforms to a cantilever one and in case of removal of the middle column slab span increases, wherein the footing zone turns into the span zone.

Fig. 19 shows the pattern of cracks in the slab tension zone and the formation of plastic hinges in compressed elements adjacent to the columns. In systems with a beam model of floors cracks are located in the vicinity of the beams.

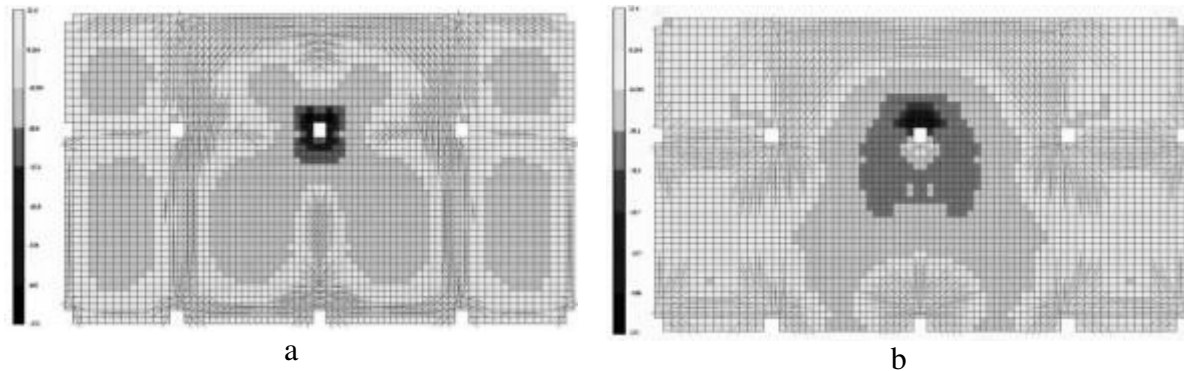

**Fig. 19. Crack distribution in slabs adjacent to the damaged cells:  
a – Slab reinforced with ribs; b – Flat slab**

Results for the model of a flat slab indicate the need for a more detailed study of the column – slab intersection zone. A model for a more comprehensive analysis of this assembly should include the capacity of reliable accounting of reinforcement in this zone.

Slab stress-strain state indicates a significant damage of concrete of emergency cells and that part of the slab reinforcement begin to yield. Despite this, the load bearing capacity of the slab is secured for the considered floor structures.

For beams situated outside of the damaged cells work the scheme remains unchanged. For beams that are within the damaged cells the scheme of work undergo certain changes (fig. 20):

- in place of compression the tension zone may occur, and vice versa;
- in beams cracks caused by tension in the concrete appear;
- in case of the corner column removal a plastic hinge is formed in the compressed zone.

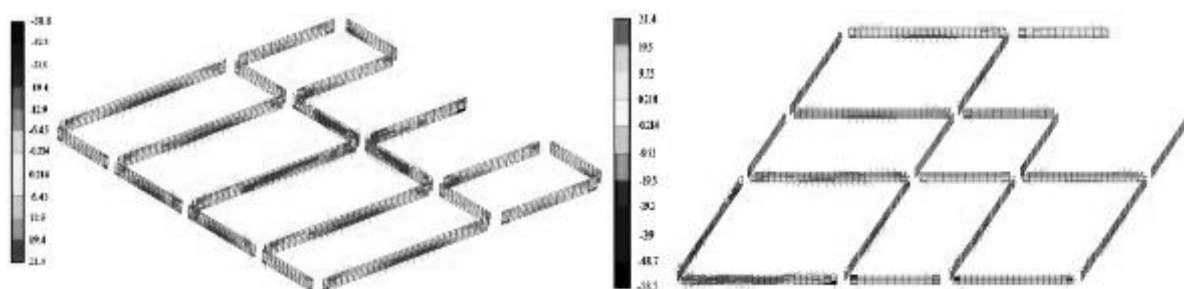

**Fig. 20. Crack distribution in beams adjacent to the damaged cells**

It was discovered that incorporation of transverse reinforcement in the calculation allows to achieve a more reliable result. Since it not only helps to withstand shear forces appearing in the cross section but also involves longitudinal reinforcement located in the compressed zone of the beam.

Capitalizing on the calculation results the comparison of the amount of necessary materials has been conducted. Its results are presented in the fig. 21 and table 3. Table 3 presents information of material consumption for 1 floor with area of 651.56 m<sup>2</sup>.

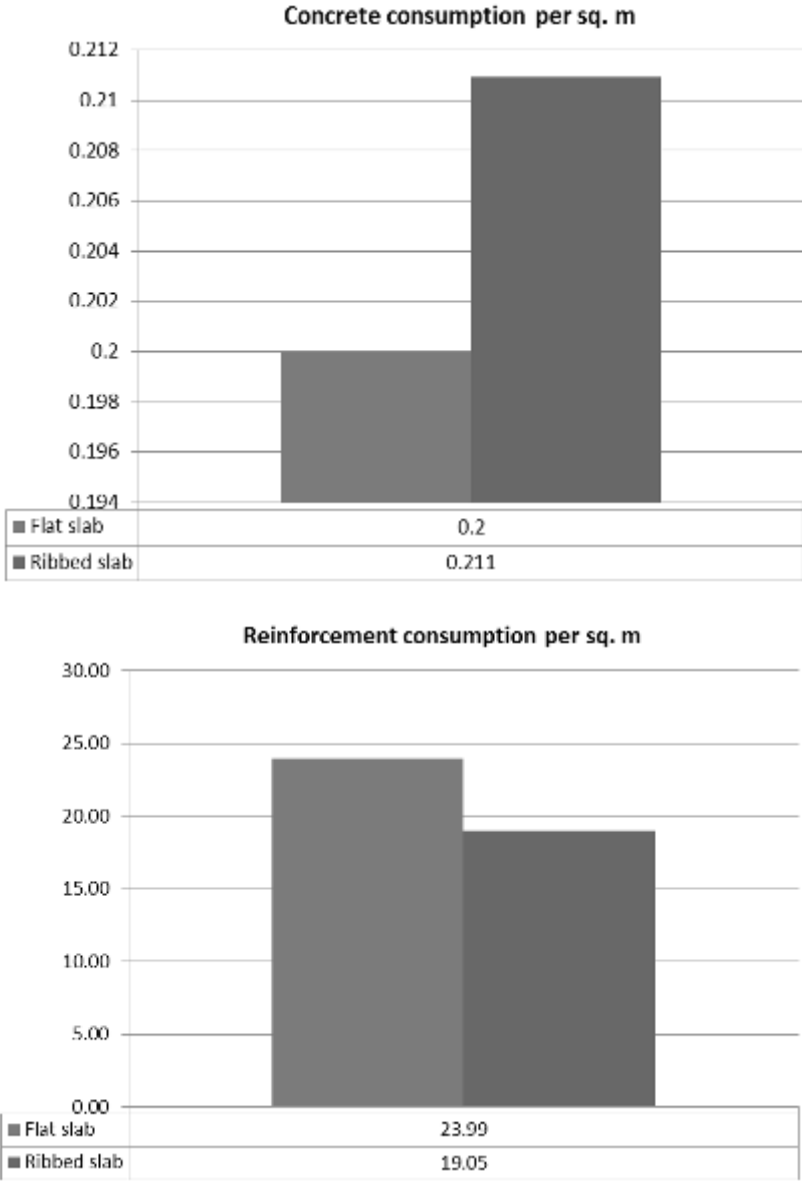
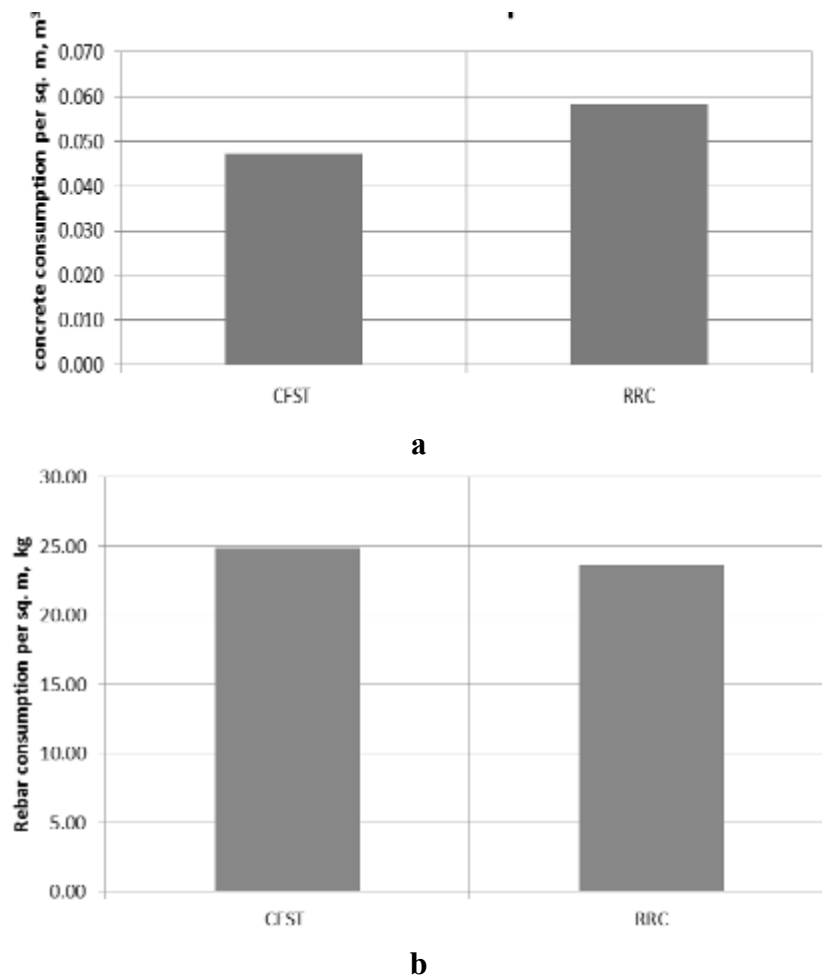

**Fig. 21. Consumption of concrete m<sup>3</sup>/m<sup>2</sup> and reinforcement kg/m<sup>2</sup>**

The results of numerical studies on the strength of the columns are shown in Table 4. The numerical experiment shows that CFST columns can withstand the load 16-17% greater than the RRC columns, while reducing the area of concrete by 10%. Such a «surplus» of bearing capacity may have a decisive influence on the behavior of structure under extreme impacts.

The obtained results confirm the data received during the experiments [11, 3, 9]. The main difference that the usage of concrete filled steel tubular (CFST) bearing structures brings compared to steel and concrete columns reinforced with flexible rebar is that in case of extreme load they are capable of withstanding such loads, whereas concrete and steel structures lose their load-bearing capacity.

Comparison of material consumption was conducted. The results are shown in Tables 5 and Figure 22. In Table 5 data on the consumption of materials is presented for one floor with the area of 651.56 m<sup>2</sup>.



**Fig. 22. Material consumption:**  
**a – Concrete consumption; b – Reinforcement consumption**

The results of assessment of explosives required to destroy the column element are the following:

$$C = A \cdot B \cdot R^3 = 20 \cdot 9 \cdot 0.6^3 = 38.88 \text{ kg.}$$

Consequently, 40 kg of explosives located in direct contact with the column must be expended for the destruction of reinforced concrete rectangular column

$$C = 6 \cdot A \cdot B \cdot R^3 = 6 \cdot 20 \cdot 9 \cdot 0.6^3 = 270 \text{ kg.}$$

Consequently, 270 kg of explosives located in direct contact with the column must be expended for the destruction of concrete filled steel tube column.

This amount of explosives can be explained by the fact that in the absence of the space for metal to deform, it is destroyed according to the strength, and not local stability factor, thereby preventing the concrete core from the direct impact of the explosion. The essential factor is the short duration of the explosive impact (characteristics of the material at such a rapid loading exceed their standard values). Similar results were confirmed in studies [2, 21, 22].

**Table 1. Consumption of reinforcement A400S, t**

<b>Consumption of reinforcement A400S, t</b>	<b>2 blocks</b>	<b>3 blocks</b>	<b>4 blocks</b>	<b>5 blocks</b>
Columns	953.30	787.51	460.90	455.93
Slabs	667.56	614.16	574.10	560.75
Beams	405.59	304.19	268.92	251.29
Outrigger blocks	53.22	79.83	106.44	133.05
Kernel	146	146	146	146
<b>Total metal consumption</b>	<b>2225.67</b>	<b>1931.69</b>	<b>1556.36</b>	<b>1547.01</b>
<b>Total metal consumption per sq. m, kg</b>	<b>76.33</b>	<b>66.24</b>	<b>53.37</b>	<b>53.05</b>

**Table 2. Concrete C32/C40 consumption, m<sup>3</sup>**

	<b>2 blocks</b>	<b>3 blocks</b>	<b>4 blocks</b>	<b>5 blocks</b>
Outrigger blocks	282.48	423.72	564.96	706.2
Columns	1227.6	1227.6	1227.6	1227.6
Beams	780.48	780.48	780.48	780.48
Slabs	5340.48	5340.48	5340.48	5340.48
Kernel	1510	1510	1510	1510
<b>Total concrete consumption per sq. m</b>	<b>0.31</b>	<b>0.32</b>	<b>0.32</b>	<b>0.33</b>

**Table 3. Concrete and reinforcement consumption for one floor**

	Concrete consumption, m <sup>3</sup>		Reinforcement consumption, kg	
	<b>flat slab</b>	<b>slab reinforced with beams</b>	<b>flat slab</b>	<b>slab reinforced with beams</b>
<i>Slab</i>	130.31	104.25	15633.87	6282.51
<i>Beam</i>	0.00	33.17	0.00	6126.77
<b>Total consumption</b>	<b>0.20</b>	<b>0.21</b>	<b>23.99</b>	<b>19.05</b>

**Table 4. Ultimate load capacity for columns**

<b>Material</b>	<b>Analyzed load</b>			<b>Combined load action</b>		
	<i>Compression, kN</i>	<i>Compression, kN</i>	<i>Bending, kN m</i>	<i>Torsion, kN m</i>	<i>Bending, kNm</i>	<i>Torsion, kNm</i>
<i>RRC</i>	16300	12634	1389	278	2071	1944
<i>CFST</i>	20478	15146	1667	336	1880	2425
<i>Margin %</i>	20.40	16.59	16.68	17.26	-10.16	19.84

**Table 5. Material consumption**

<b>Material consumption</b>	<b>CFST</b>	<b>RRC</b>
<i>Concrete consumption per columns of one floor, m<sup>3</sup></i>	30.86	38.02
<i>Concrete consumption m<sup>3</sup> per sq. m</i>	0.047	0.058
<b>Reinforcement consumption, kg</b>	<b>CFST</b>	<b>RRC</b>
<i>Longitudinal reinforcement</i>	16214.46	13263.36
<i>Transverse reinforcement</i>	0	2122.14
<b><i>In total per one floor</i></b>	16214.46	15385.50
<b><i>In total per one sq. m</i></b>	24.89	23.61

**Conclusions.** The purpose of this paper has been to analyze different design measures devised to ensure structure durability in case of progressive collapse and find the most efficient ones. Based upon the FEM calculations and discussion given above the following conclusions can be made:

1. Outrigger block on the 2nd floor can significantly reduce the potential damage to the structure in case of the most probable of collapse scenario.
2. The number of blocks is a significant parameter for determining the stability of the structure to the progressive collapse, therefore the usage of fewer blocks may increase the reinforcement of the main load-bearing structures of the building. From the comparison presented above it can be concluded that the best results for such structure could be achieved by using 4 – 5 blocks. Both these cases have shown almost similar material consumption.
3. It was found that in the case of progressive collapse, a slab reinforced with beams model is better than the flat slab, since the beams significantly reduce the stress and displacement of the floor construction. At the same time, the comparison of material consumption of floor options showed that the beam model is much more economically efficient than the flat slab model.
4. It was found that CFST column collapses under the load up to 16-19% higher than the RC column, while the cost of the compared columns remains almost the same.
5. The obtained data indicate that by using a CFST column we save up to 23% of concrete used for columns construction.
6. According to [17] it was found that in order to destroy a CFST column it is necessary to spend up to 270 kg of explosives. While for the demolition of reinforced concrete rectangular columns with a flexible reinforcement, the necessary amount of explosives is up to 40 kg.

All this data proves that by using different structural design measures we can significantly reduce the risks of progressive collapse and ensure the construction durability while keeping the costs of such measures low enough.

### **References**

1. Baldrige Steven, Humay Francis, *Seismic design details are the key to ductility and load transfer*, Concrete international, 2011.
2. Belov N.N. *Calculation of reinforced concrete structures on the blast and shock* / N.N. Belov, D.G. Kopanitsa – Northampton – Tomsk: STT. – 2004. – 465 p.
3. Belov N.N. *Strength calculation models of steel encased concrete columns on multiple longitudinal blow*. Herald TGASU. – 2009. – № 4. – P. 10.
4. *Best Practices for Reducing the Potential for Progressive Collapse in Buildings* / Bruce R. Ellingwood, Robert Smilowitz, Donald O. Dusenberry, Dat Duthinh, H.S. Lew, & Nicholas J. Carino (National Institute of Standards and Technology – 2007).

5. Cai S.H. *Ultimate strength of concrete-filled tube columns*, *Composite construction in steel and concrete*. New Hampshire, June 1987, ASCE. – PP. 702 – 727.
6. Comité Européen de Normalisation, (2002), *Draft prEN 1992-1-1: July 2002, Eurocode 2. Design of concrete structures Part 1: General rules and rules for buildings*, Brussels.
7. David Drengenberg, Gene Corley. *Evolution of building code requirements in a post 9/11 world*, *CTBUH journal issue III*, 2011.
8. Gorodetsky A., Evzerov I. *Computer models of structures*. – Kiev «Aakt», 2005.
9. Han-Soo Kim, Jae-Gyun Ahn, Hao-Seung Ahn. *Numerical simulation of progressive Collapse for a reinforced concrete building*. *World academy of science Engineering and technology* 76, Beijing 2013.
10. Kikin A.I. *Design of steel tubes filled with concrete* / A.I. Kikin, R.A. Sanzharovsky, V.A. Troole. – Moscow: Stroyizdat, 1974. – 145 p.
11. Krishan A.L. *Determination of the breaking load of compressed concrete filled steel tube elements* / A.L. Krishan, A. Zaikin, M.S. Kupfer. – *Concrete and reinforced concrete*. – 2009. – № 2.
12. Loskytov I. *Ribbed slabs and progressive collapse* / I. Loskytov, D. Glotkov, O. Kantyr. <http://www.Katriel.ru>.
13. *Manual on demolition work [Text]*/ ed. V.F. Mashevsky, T.F. Myasnikov. – 5th ed. – Moscow: Military Publishing House of Defense ministry of the USSR, 1959. – 464 p.
14. *Minregionbud of Ukraine, DBN B.2.2-24 2009 «Design of high-rise residential and administrative buildings»*. – Kyiv, 2006.
15. Nesterovich A.P. *Strength of compressed concrete filled steel tube elements with a diameter of 500 mm or more in axial compression: Diss... Candidate . tech. Science*. – M., 1987. – 236 p.
16. *Progressive Collapse Analysis and Design Guidelines for New Federal Office Buildings and Major Modernization Projects*, David N., S.E. & Mahmoud Kamara, (Portland Cement Association 2003).
17. Rastorgouev B.S. *Deformation of floor construction of frame buildings after the sudden destruction of one column* / B.S. Rastorgouev, K.N. Mutoka // *Earthquake engineering. Security structures*. – 2006. – № 1. – P. 12-15.
18. *Review of international research on structural robustness and disproportionate collapse*, Department for Communities and Local Government, London DCLG Publications, 2011.
19. Sanzharovsky R.S. *Theory and calculation of the strength and stability of structural elements of steel tubes filled with concrete*. – Moscow, 1977. – 453 p.
20. Storozenko L.I. *Composite structures* / L.I. Storozenko, A. Semko, V.I. Efymenko. – Kyiv: The fourth Hvilya, 1997.
21. Storozenko L.I. *Comparison of methods for calculating the compressed concrete filled steel tube structures* / L.I. Storozenko, A. Semko // *Public hazyaystvo cities*. – 2005.
22. *Technical recommendations for risk analysis of terrorist attacks and zoning of high-rise and unique objects, designed by the Moscow Research Institute of Construction – TR 204-09*. – Moscow, 2009.
23. Tihonov I.N., *Reinforcement detailing of monolithic reinforced concrete buildings. Manual of engineering*. FSUE «SRC» Construction». – Moscow: 2007. – 169 p.
24. Xinzheny Lu. *Application of fiber model for progressive collapse analysis of reinforced concrete frame* / Lu Xinzheny, Yi Li, Ye Lieping, Yi Liang. – InCiTe Beijing, 2008.